

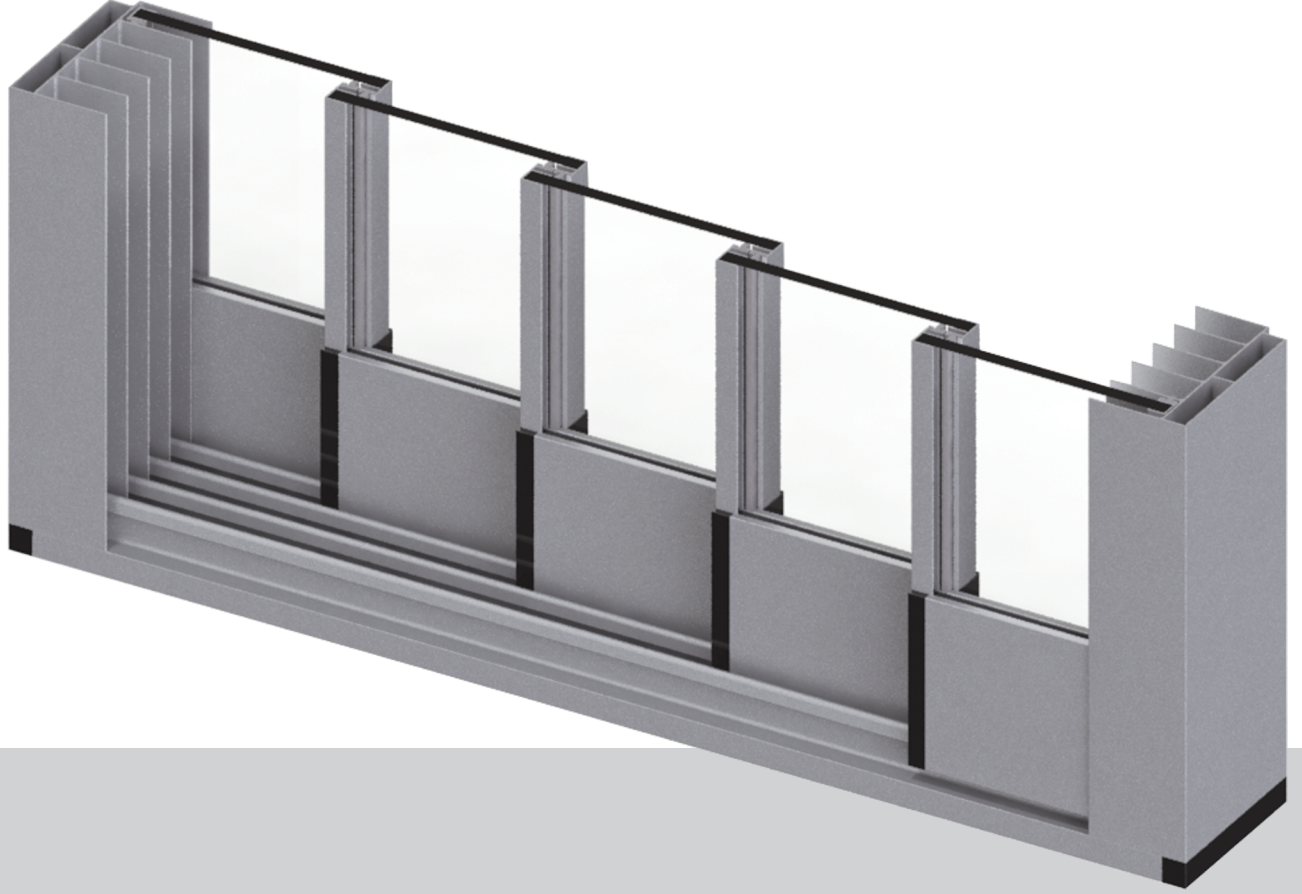

Dış Mekan Sistem
Outdoor System

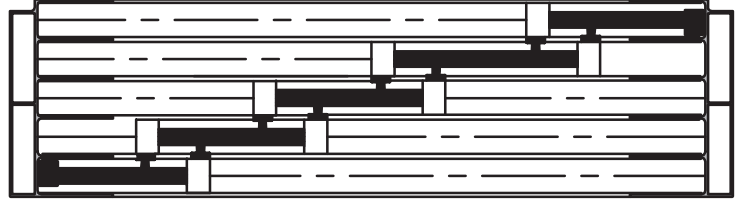

SCB100

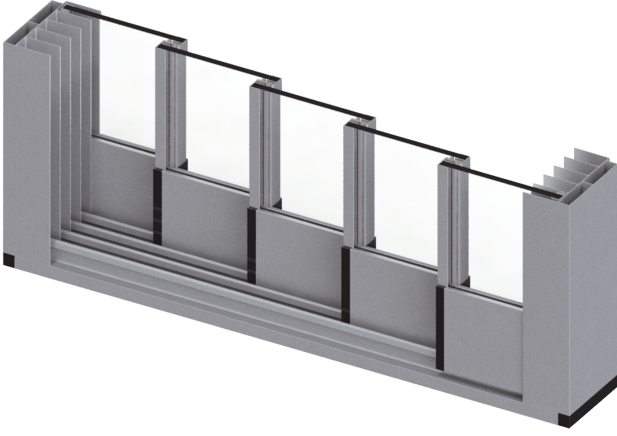

TEKNİK ÖZELLİKLER / TECHNICAL PROPERTIES

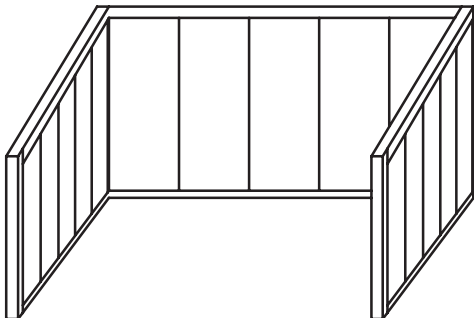
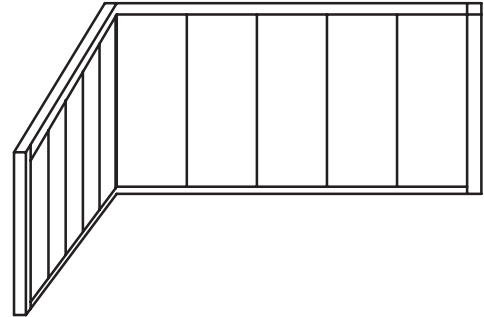
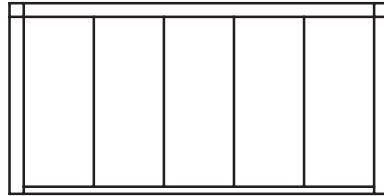
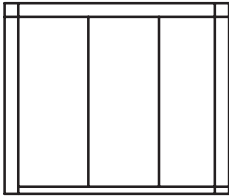

KASA GENİŞLİĞİ / FRAME WIDTH	58 - 101 mm
KANAT GENİŞLİĞİ / SASH WIDTH	17,5 mm
PROFİL ET KALINLIĞI / PROFILE WALL THICKNESS	1,4 mm - 1,7 mm
CAM KALINLIĞI / GLASS THICKNESS	8 - 10 mm
MAKS. KANAT GENİŞLİĞİ / MAX. SASH WIDTH	1000 mm
MAKS. KANAT YÜKSEKLİĞİ / MAX. SASH HEIGHT	3000 mm
MAKS. KANAT AĞIRLIĞI / MAX. SASH WEIGHT	70 kg
MAKS. KANAT SAYISI / MAX. SASH NUMBER	5 Sol / 5 Sağ - 5 Left / 5 Right

UYGULAMA SEÇENEKLERİ / APPLICATION OPTIONS

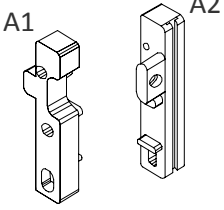
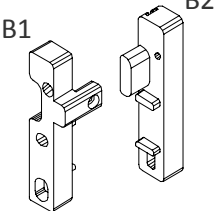
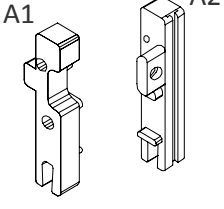
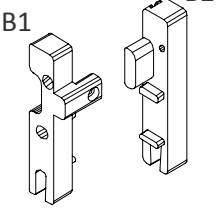
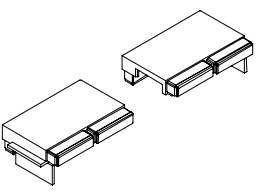
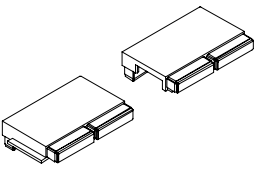
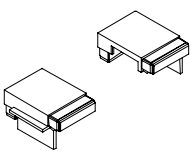

PROF L KES T PROFILE SECTION	PROF L KODU PROFILE CODE	PROF L ADI PROFILE NAME	Jx cm ⁴	Jy cm ⁴	A IRLIK (kg/m) WEIGHT
	12016	3 RAYLI E KS Z ALT RAY PROF L BOTTOM TRIPLE RAIL PROFILE (NON-THRESHOLD)	-	-	0,352 kg/m
	9678	5 RAYLI E KS Z ALT RAY PROF L BOTTOM QUINTUPLE RAIL PROFILE (NON-THRESHOLD)	-	-	0,759 kg/m
	12015	3 RAYLI E KL ALT RAY PROF L BOTTOM TRIPLE RAIL PROFILE (THRESHOLD)	-	-	0,715 kg/m
	5425	5 RAYLI E KL ALT RAY PROF L BOTTOM QUINTUPLE RAIL PROFILE (THRESHOLD)	-	-	1,737 kg/m
	12014	3 RAYLI ÜST-YAN KASA PROF L TOP-SIDE TRIPLE FRAME PROFILE	-	-	1,032 kg/m
	5430	5 RAYLI ÜST-YAN KASA PROF L TOP-SIDE QUINTUPLE FRAME PROFILE	-	-	1,533 kg/m
	12017	ALT KANAT PROF L (8 mm) BOTTOM SASH PROFILE (8 mm)	-	-	1,189 kg/m
	12018	ALT KANAT PROF L (10mm) BOTTOM SASH PROFILE (10 mm)	-	-	1,165 kg/m
	5429	ÜST KANAT PROF L (8 mm) TOP SASH PROFILE (8 mm)	-	-	0,156 kg/m
	6198	YAN KANAT PROF L (8 mm) SIDE SASH PROFILE (8 mm)	-	-	0,143 kg/m
	7187	SON KANAT PROF L (8 mm) LAST SASH PROFILE (8 mm)	-	-	0,098 kg/m
	7326	CAM H PROF L (8 mm) GLAZING H PROFILE (8 mm)	-	-	0,169 kg/m
	6196	ÜST KANAT PROF L (10mm) TOP SASH PROFILE (10 mm)	-	-	0,143 kg/m
	6199	YAN KANAT PROF L (10 mm) SIDE SASH PROFILE (10 mm)	-	-	0,134 kg/m
	7191	SON KANAT PROF L (10 mm) LAST SASH PROFILE (10 mm)	-	-	0,106 kg/m
	8766	CAM H PROF L (10 mm) GLAZING H PROFILE (10 mm)	-	-	0,196 kg/m
	9676	KULP PROF L (10mm) HANDLE PROFILE (10 mm)	-	-	0,640 kg/m

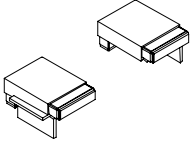
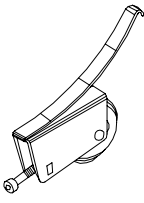
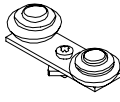
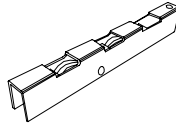
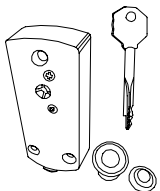
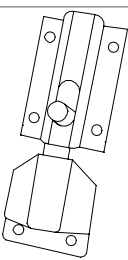
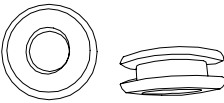
AKSESUAR ACCESSORY	STOK KODU REFERENCE CODE	AKSESUAR ADI DESCRIPTION	AKSESUAR KODU PRODUCT CODE	PAKET PACK
	13 500102	EŞİKSİZ / ALT KANAT KAPAĞI SOLA AÇILIR BOTTOM SASH COVER (NON-THRESHOLD / LEFT)	SCB100-İZ.A1	400 Tk / paket
	13 500103	EŞİKSİZ / ALT KANAT KAPAĞI SAĞA AÇILIR BOTTOM SASH COVER (NON-THRESHOLD / RIGHT)	SCB100-İZ.B1	400 Tk / paket
	13 500104	EŞİKLİ / ALT KANAT KAPAĞI SOLA AÇILIR BOTTOM SASH COVER (THRESHOLD / LEFT)	SCB100-Lİ.A1	400 Tk / paket
	13 500105	EŞİKLİ / ALT KANAT KAPAĞI SAĞA AÇILIR BOTTOM SASH COVER (THRESHOLD / RIGHT)	SCB100-Lİ.B1	400 Tk / paket
	13 500111	5 RAYLI ALT KASA KÖŞE TAKOZU QUINTUPLE RAIL CORNER JOINT (BOTTOM)	SCB100-5K.01	100 Tk / paket
	13 500112	5 RAYLI ÜST KASA KÖŞE TAKOZU QUINTUPLE RAIL CORNER JOINT (TOP)	SCB100-5K.02	100 Tk / paket
	13 500107	3 RAYLI ALT KASA KÖŞE TAKOZU TRIPLE RAIL CORNER JOINT (BOTTOM)	SCB100-3K.01	100 Tk / paket

AKSESUAR ACCESSORY	STOK KODU REFERENCE CODE	AKSESUAR ADI DESCRIPTION	AKSESUAR KODU PRODUCT CODE	PAKET PACK
	13 500108	3 RAYLI ÜST KASA KÖ E TAKOZU TRIPLE RAIL CORNER JOINT (TOP)	SCB100-3K.02	100 Tk / paket
	13 500100	E KS Z KASA TEKL ALT RULMAN BOTTOM SINGLE ROLLER (NON-THRESHOLD)	SCB100- Z.10	100 ad / paket
	13 500101	ÜST RULMAN TOP ROLLER	SCB100-ÜR.01	100 ad / paket
	13 500109	E KL KASA ALT RULMAN BOTTOM ROLLER (THRESHOLD)	SCB100-L .10	100 ad / paket
	05 030100	E KS Z S STEM KL T SLIDING LOCK (NON-THRESHOLD)	SCB100- Z.20	2 ad / paket
	13 500125	E KL F EK SÜRGÜ KL T THRESHOLD TOWER BOLT	SCB100-L .20	1 ad / paket
	13 500120	SÜRME KOL SLIDING HANDLE	SCB100-SK.01	10 ad / paket
	03 050712	FIRÇA FT L WEATHER STRIP	SCB100-FÇ.712	200 mt / paket

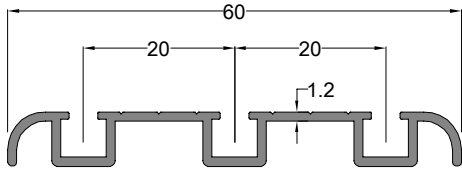

3 Raylı Eşiksiz Alt Ray Profili
BOTTOM TRIPLE RAIL PROFILE (NON-THRESHOLD)

Profil Kodu Profile Code	(kg/mt) Weight
12016	0,352

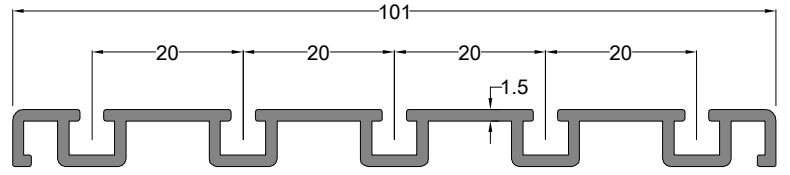

5 Raylı Eşiksiz Alt Ray Profili
BOTTOM QUINTUPLE RAIL PROFILE (NON-THRESHOLD)

Profil Kodu Profile Code	(kg/mt) Weight
9678	0,759

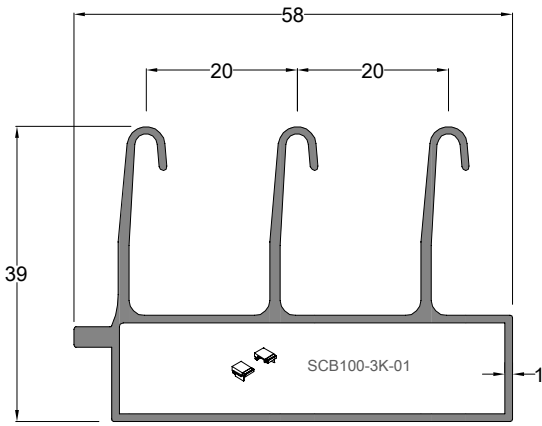

3 Raylı Eşikli Alt Ray Profili
BOTTOM TRIPLE RAIL PROFILE (THRESHOLD)

Profil Kodu Profile Code	(kg/mt) Weight
12015	0,715

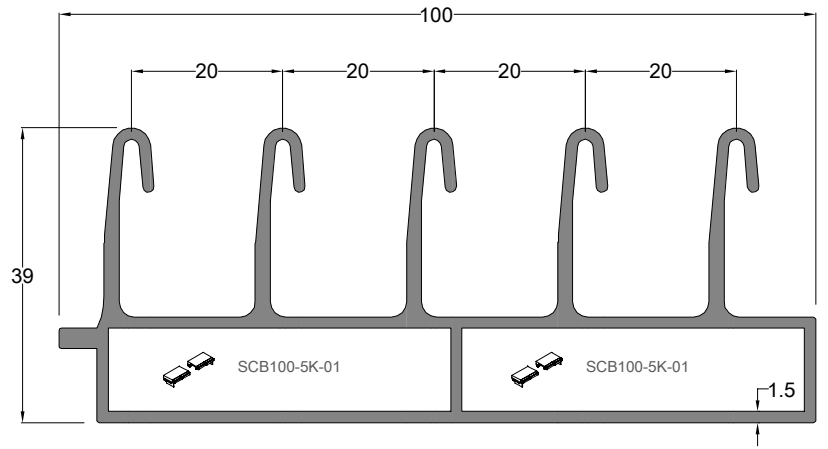

5 Raylı Eşikli Alt Ray Profili
BOTTOM QUINTUPLE RAIL PROFILE (THRESHOLD)

Profil Kodu Profile Code	(kg/mt) Weight
5425	1,737

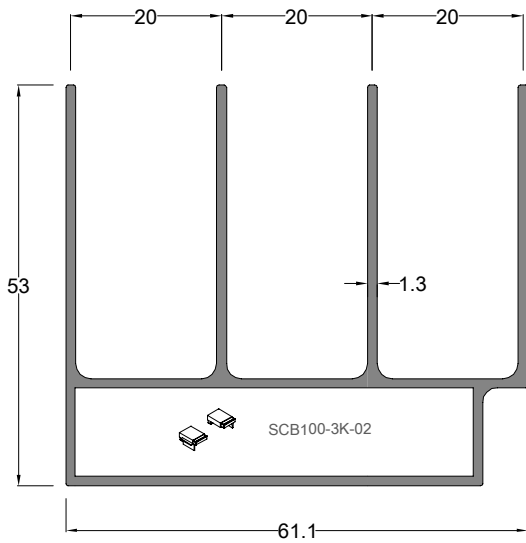

3 Raylı Üst-Yan Kasa Profili
TOP-SIDE TRIPLE FRAME PROFILE

Profil Kodu Profile Code	(kg/mt) Weight
12014	1,032

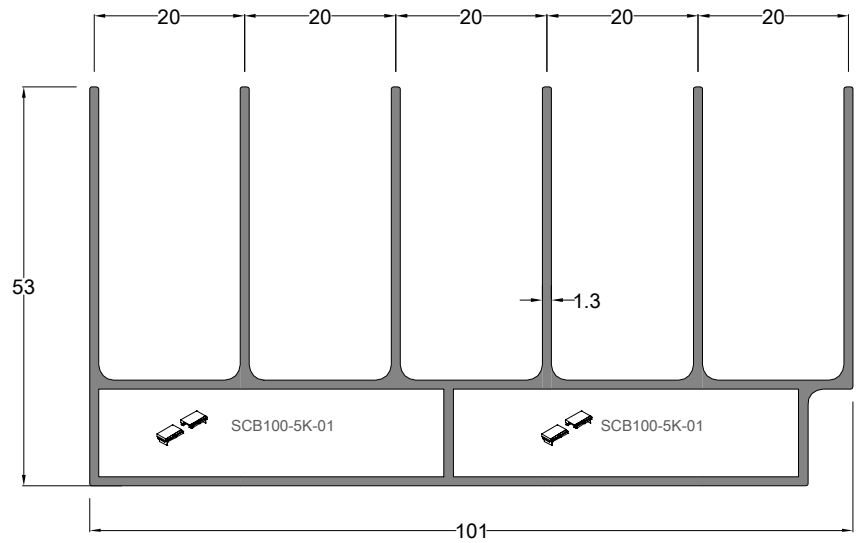

5 Raylı Üst-Yan Kasa Profili
TOP-SIDE QUINTUPLE FRAME PROFILE

Profil Kodu Profile Code	(kg/mt) Weight
5430	1,533

** Her profil için minimum sipariş 300 kg'dır.
** Minimum order quantity is 300 kg per profile.

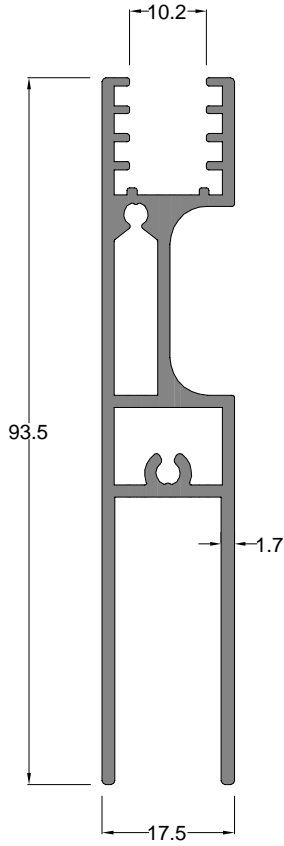

Alt Kanat 10 mm	Profil Kodu	(kg/mt)
BOTTOM SASH PROFILE (10 MM)	Profile Code	Weight
	12018	1,165

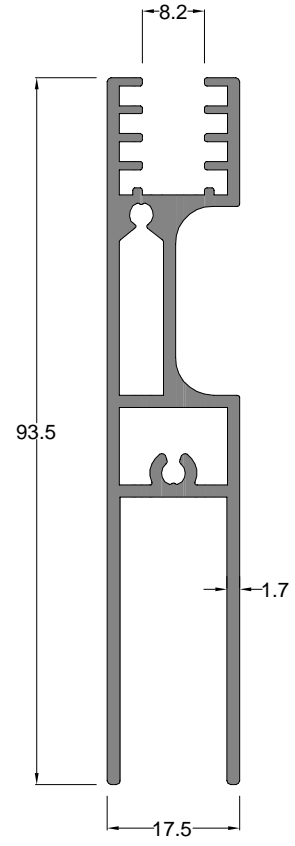

Alt Kanat 8 mm	Profil Kodu	(kg/mt)
BOTTOM SASH PROFILE (8 MM)	Profile Code	Weight
	12017	1,189

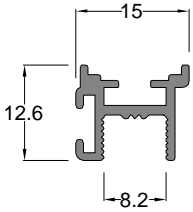

Üst Kanat Profili 8 mm	Profil Kodu	(kg/mt)
TOP SASH PROFILE (8 MM)	Profile Code	Weight
	5429	0,156

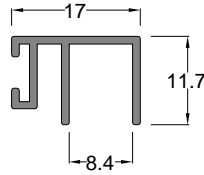

Yan Kanat Profili 8 mm	Profil Kodu	(kg/mt)
SIDE SASH PROFILE (8 MM)	Profile Code	Weight
	6198	0,143

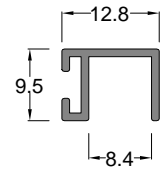

Son Kanat 8 mm	Profil Kodu	(kg/mt)
LAST SASH PROFILE (8 MM)	Profile Code	Weight
	7187	0,098

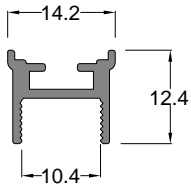

Üst Kanat 10 mm	Profil Kodu	(kg/mt)
TOP SASH PROFILE (10 MM)	Profile Code	Weight
	6196	0,143

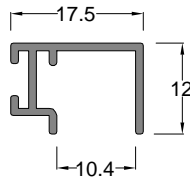

Yan Kanat 10 mm	Profil Kodu	(kg/mt)
SIDE SASH PROFILE (10 MM)	Profile Code	Weight
	6199	0,134

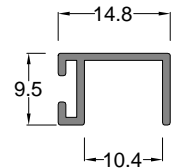

Son Kanat 10 mm	Profil Kodu	(kg/mt)
LAST SASH PROFILE (10 MM)	Profile Code	Weight
	7191	0,106

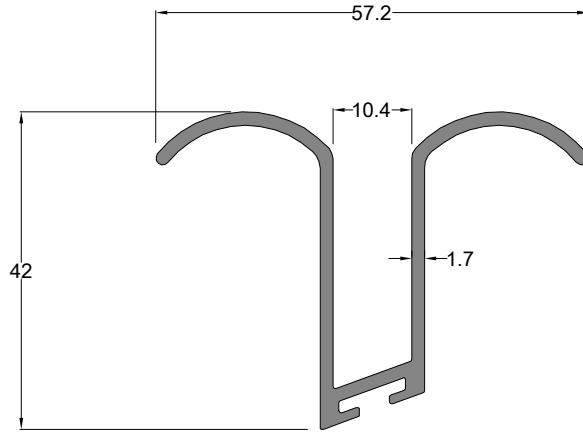

Kulp Profili 10 mm	Profil Kodu	(kg/mt)
HANDLE PROFILE (10 MM)	Profile Code	Weight
	9676	0,640

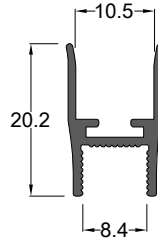

Cam H Profili (8 mm)	Profil Kodu	(kg/mt)
GLAZING H PROFILE (8 MM)	Profile Code	Weight
	7326	0,169

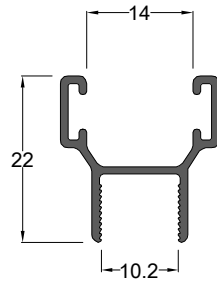

Cam H Profili (10 mm)	Profil Kodu	(kg/mt)
GLAZING H PROFILE (10 MM)	Profile Code	Weight
	8766	0,196

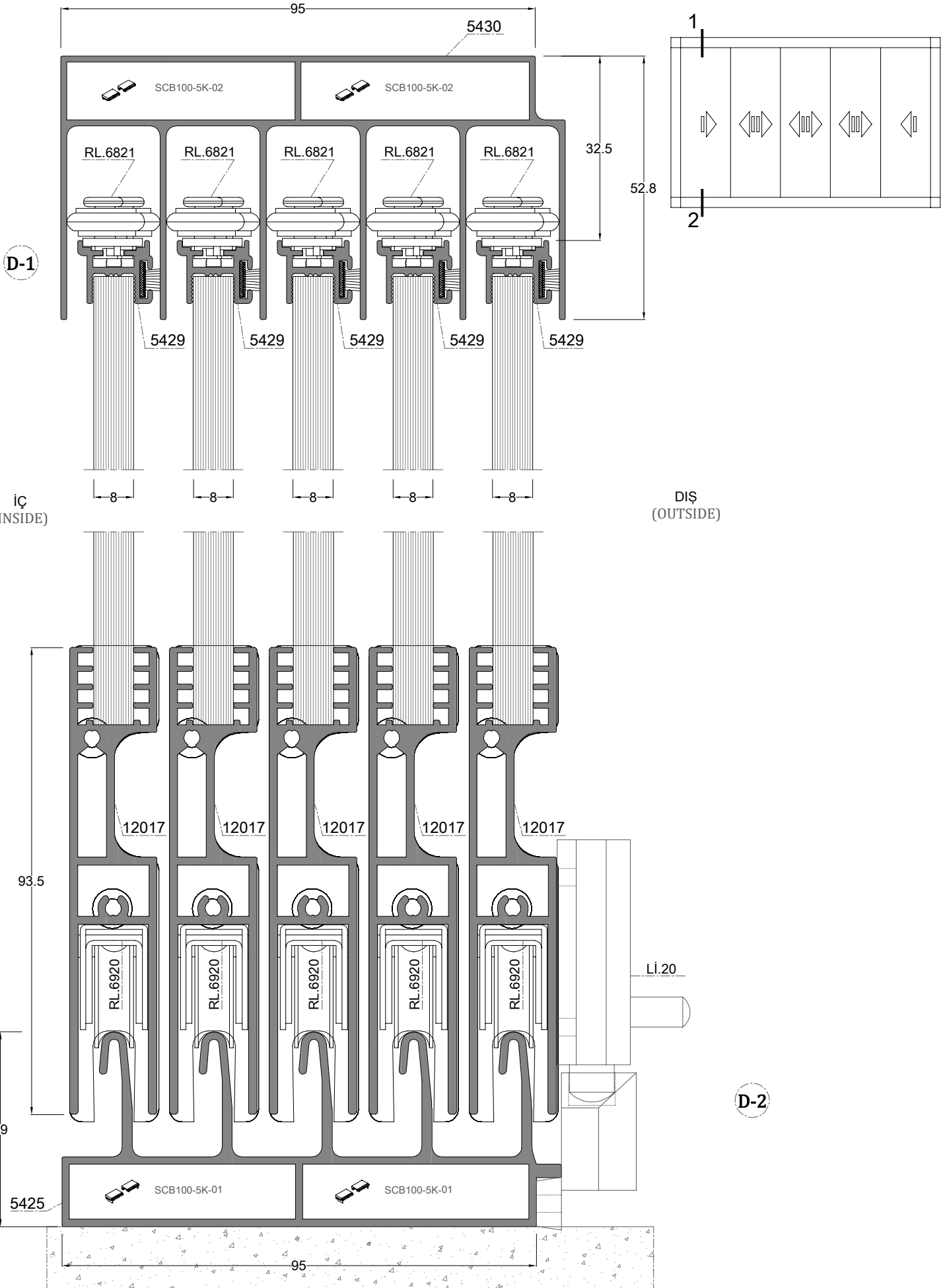

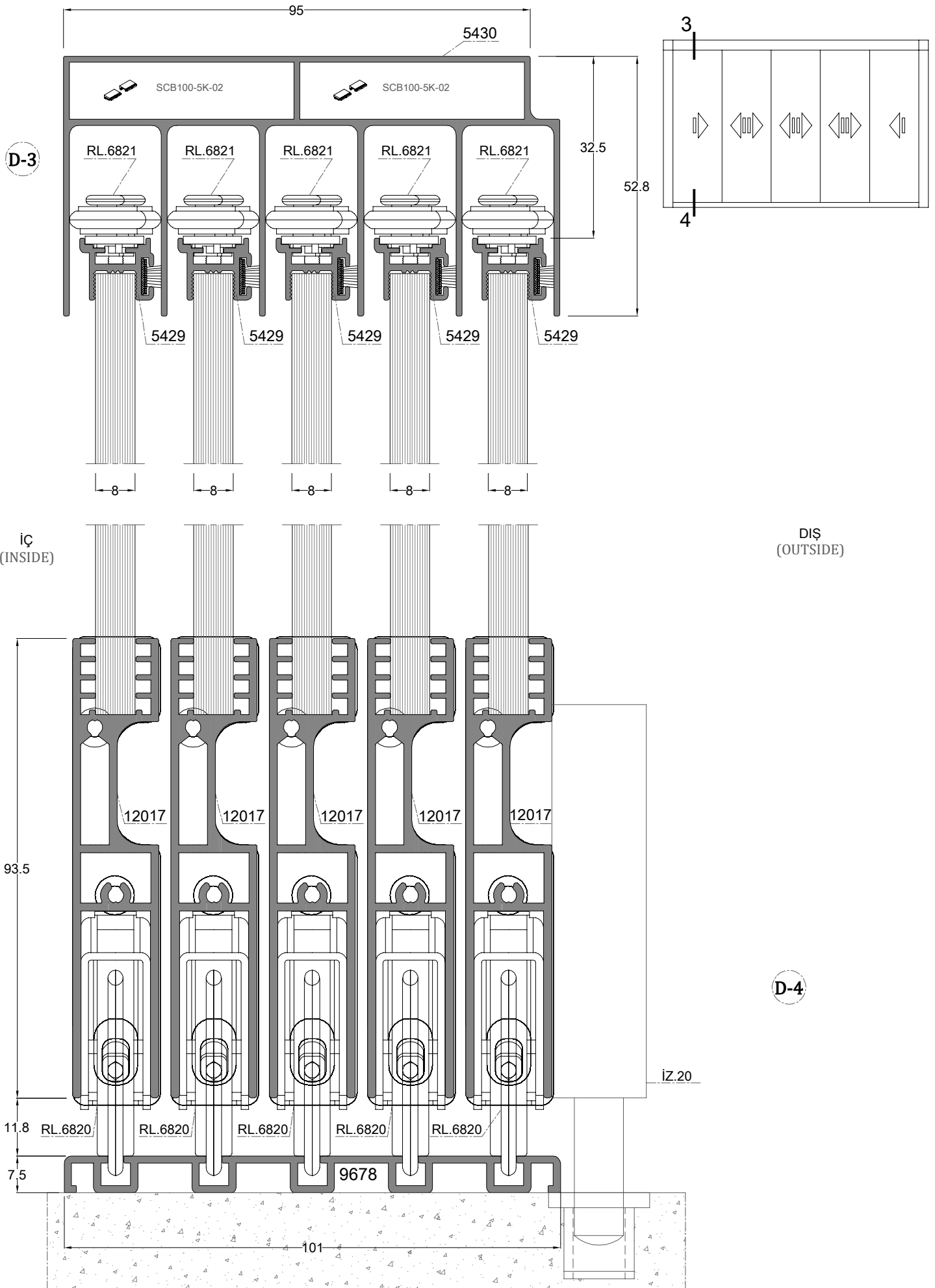

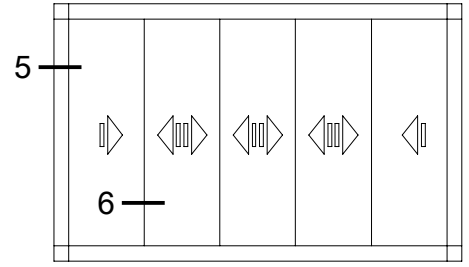
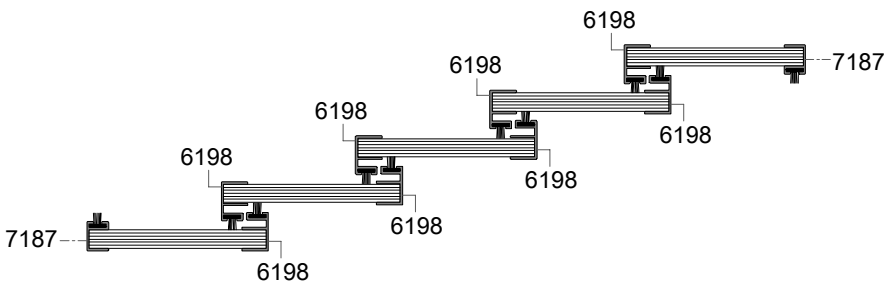

DİŞ
(OUTSIDE)

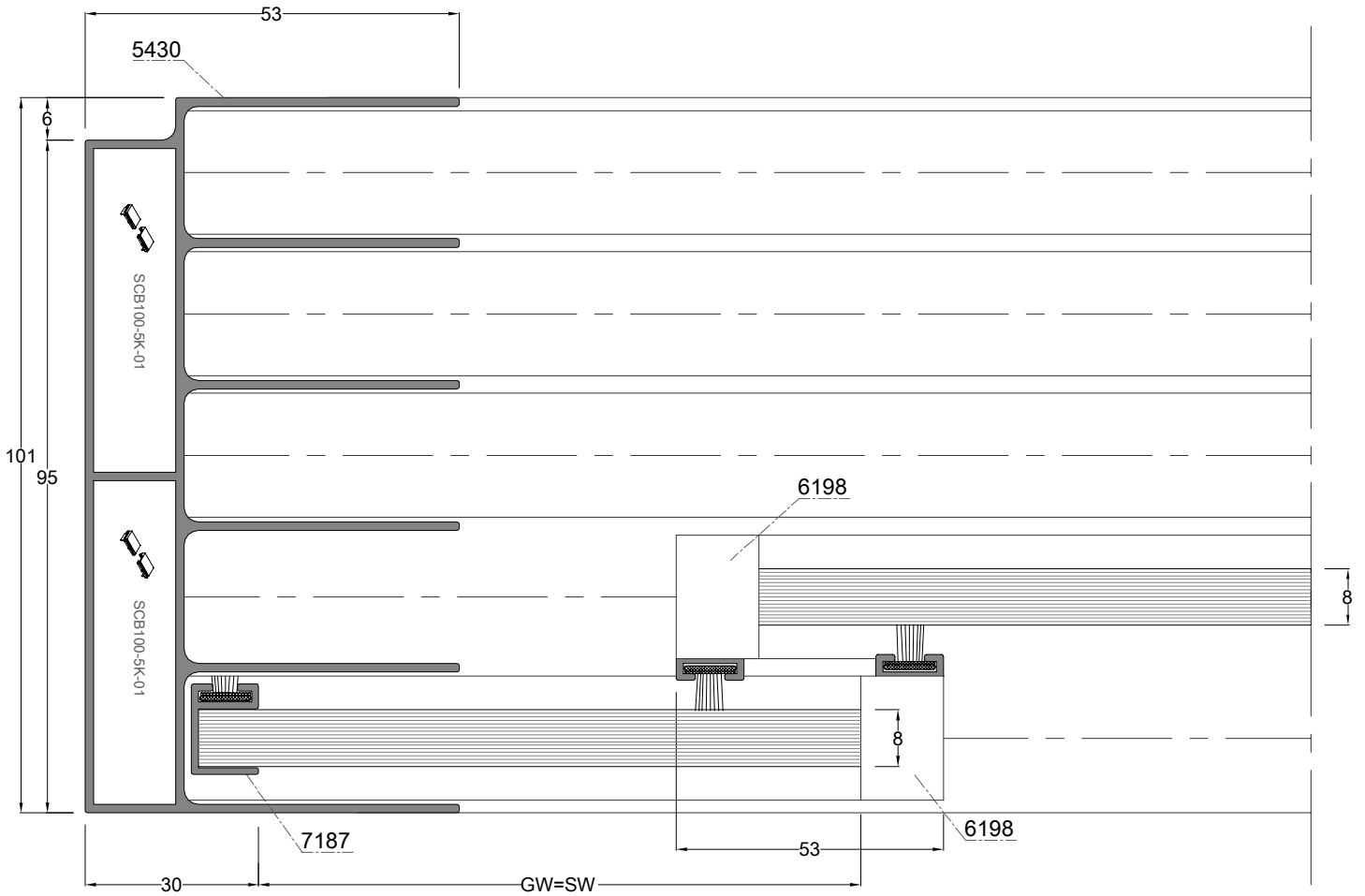

D-5

D-6

İÇ
(INSIDE)

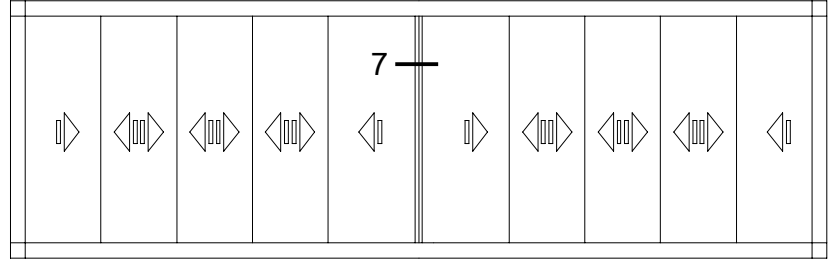

DIŞ
(OUTSIDE)

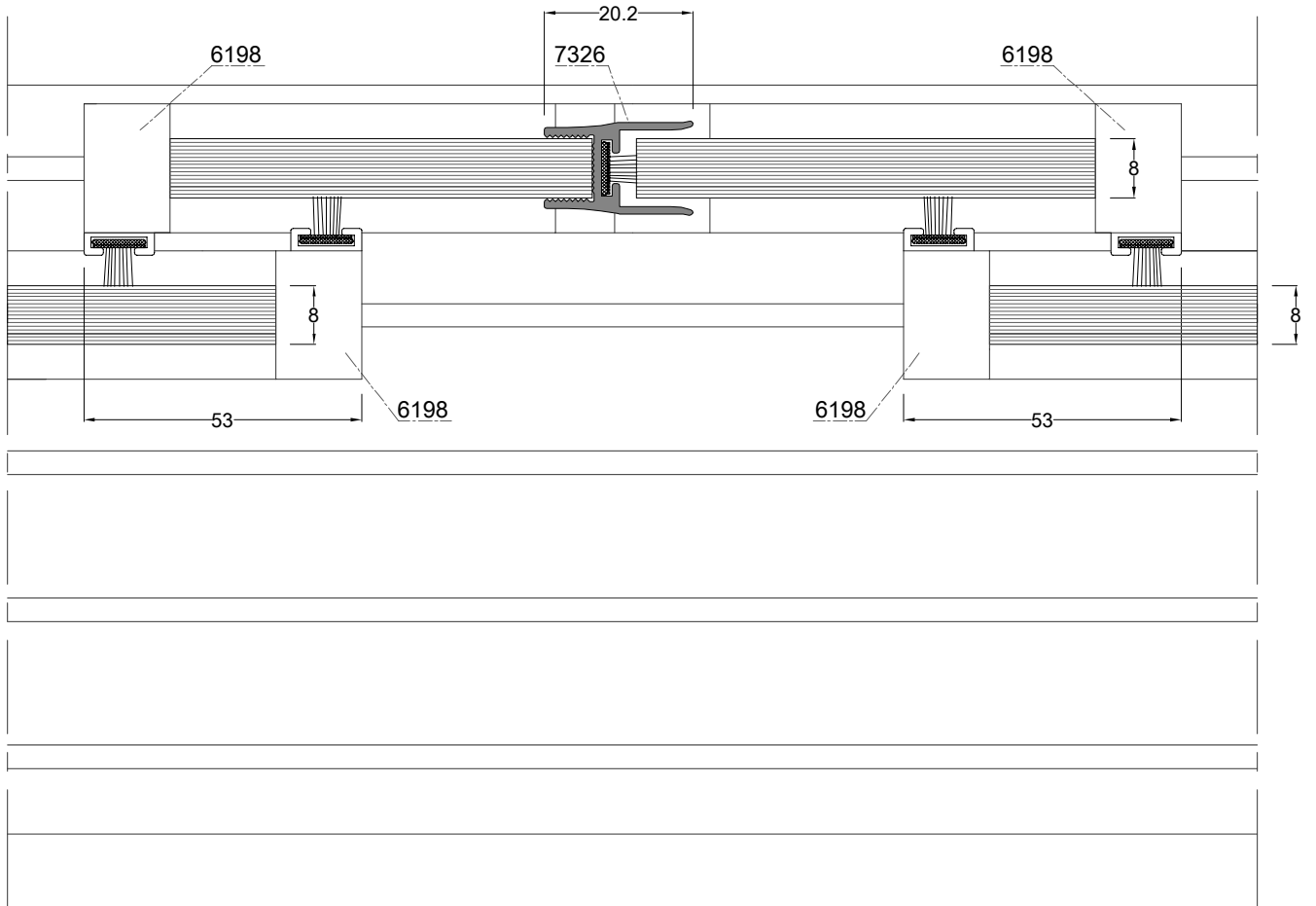

İÇ
(INSIDE)

D-7

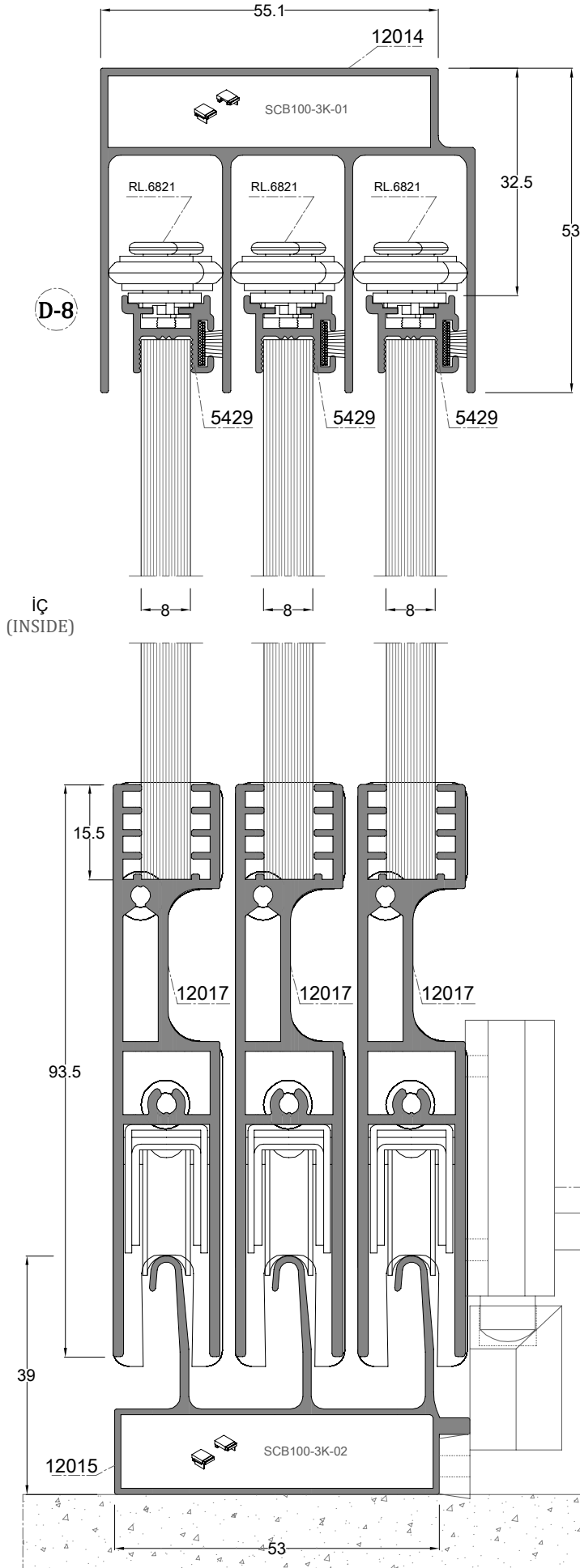

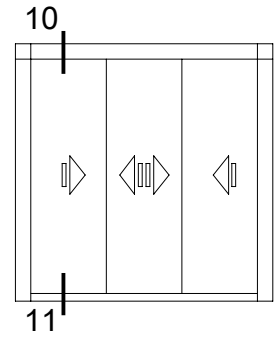
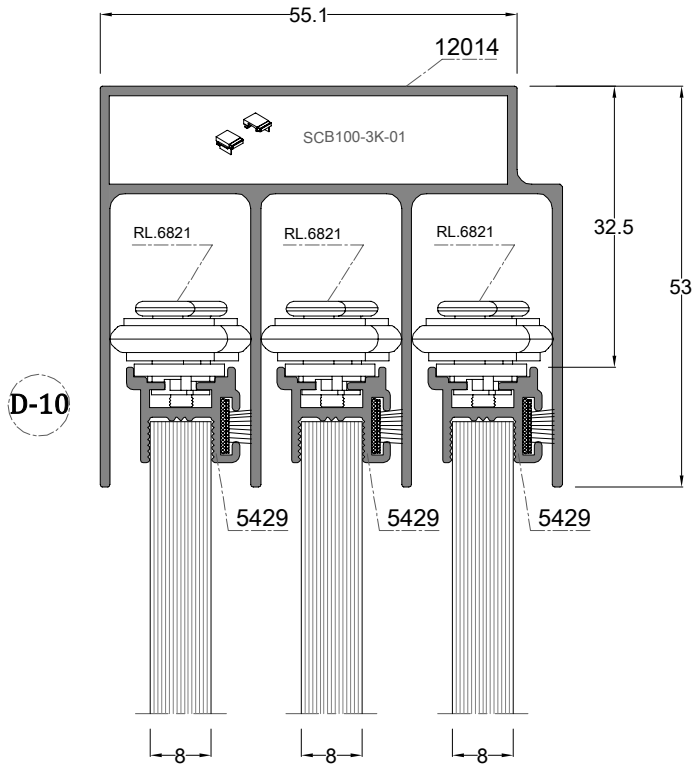

İÇ
(INSIDE)

DIŞ
(OUTSIDE)

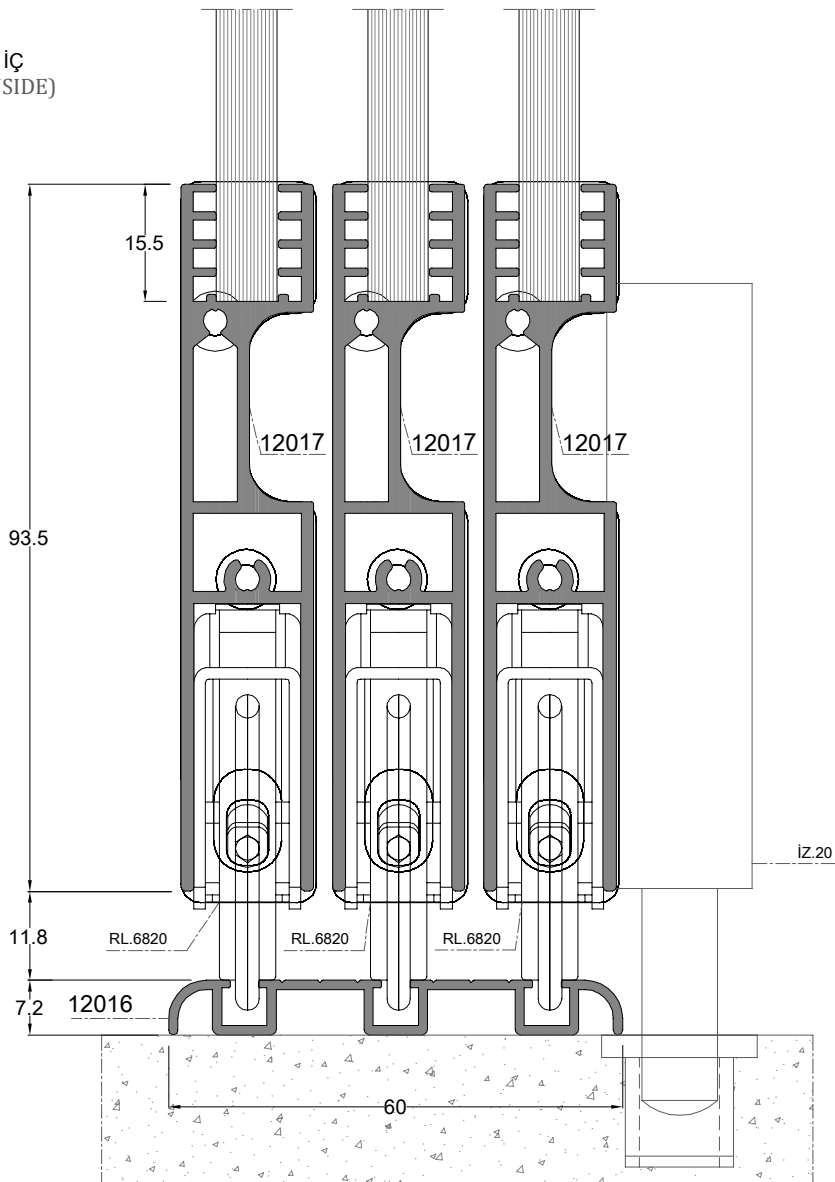

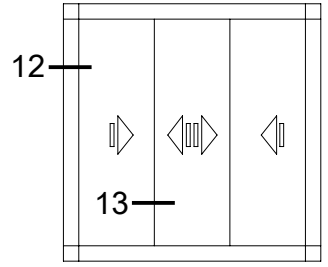

DIŞ
(OUTSIDE)

D-13



D-12

İÇ
(INSIDE)

Eşikli Sistem Kesim Ölçüsü

PROFILE CUTTING DIMENSION FOR THRESHOLD SYSTEM

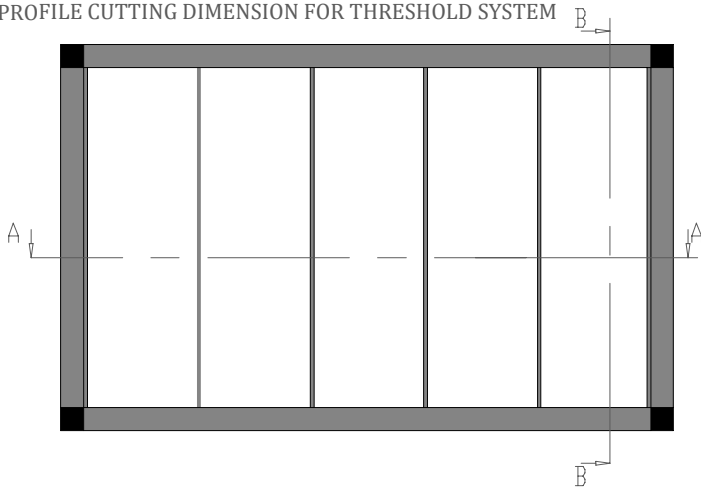

PROFİLLER / PROFILES

Kod Code	Çizim Drawing	Kesim Cut	Miktar Quantity	Ölçüler Dimensions
5425 Ray Profili Rail Profile			1Pcs / Adet	L-104
5430 Üst Kasa Top Frame			1Pcs / Adet	H-104
5430 Yan Kasa Side Frame			2Pcs / Adet	H-30
12017 Alt Kanat Bottom Sash			A (Kanat Adeti) x 1	$\frac{L}{A} + 8$
5929 Üst Kanat Top Sash			A x 1	$\frac{L}{A} + 8$
7187 Son Kanat End Sash			2Pcs / Adet	H-168
6198 Ara Kanat Middle Sash			8Pcs / Adet	

CAM / GLAZING

Kod Code	Çizim Drawing	Miktar Quantity	Ölçüler Dimensions
CAM GLAZING		5 Pcs / Adet	GH=H-152
			$GL = \frac{L}{A} + 8$

CAM ÖLÇÜLER EĞİT KABUL EDİLEREK FORMÜLE EDİLMİŞTİR.
GLAZING DIMENSIONS ARE ASSUMED TO BE EQUAL.

B-B KESİTİ

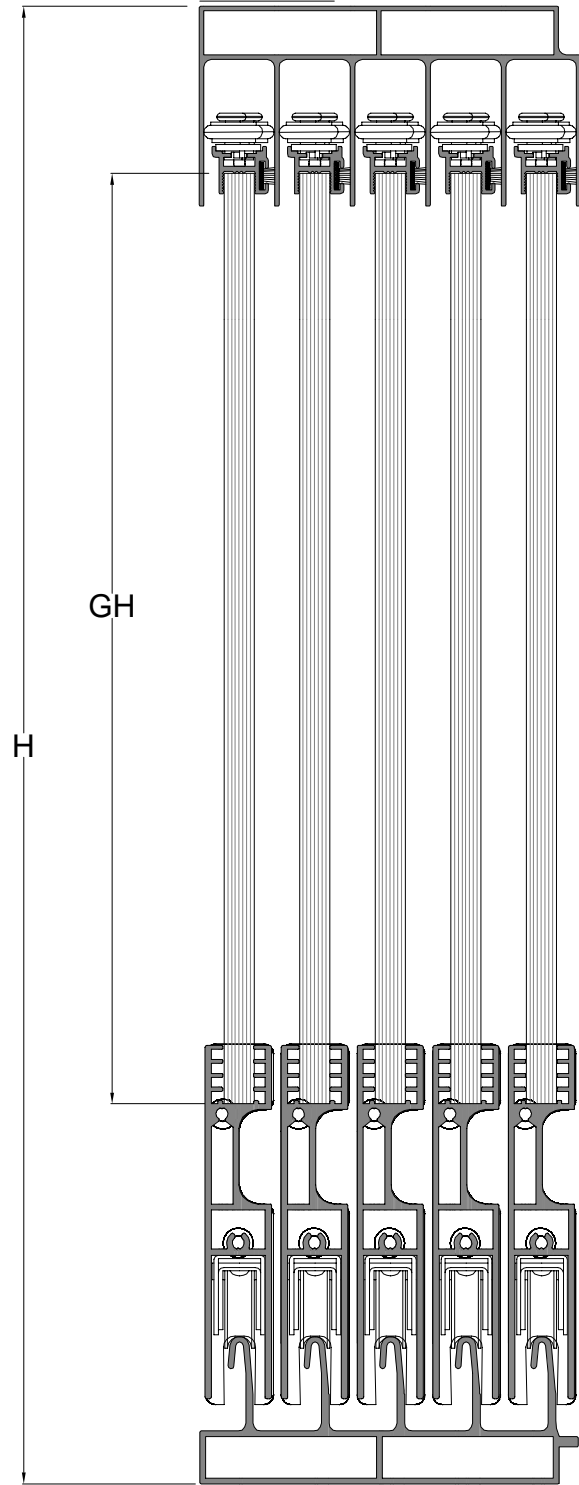

A-A KESİTİ

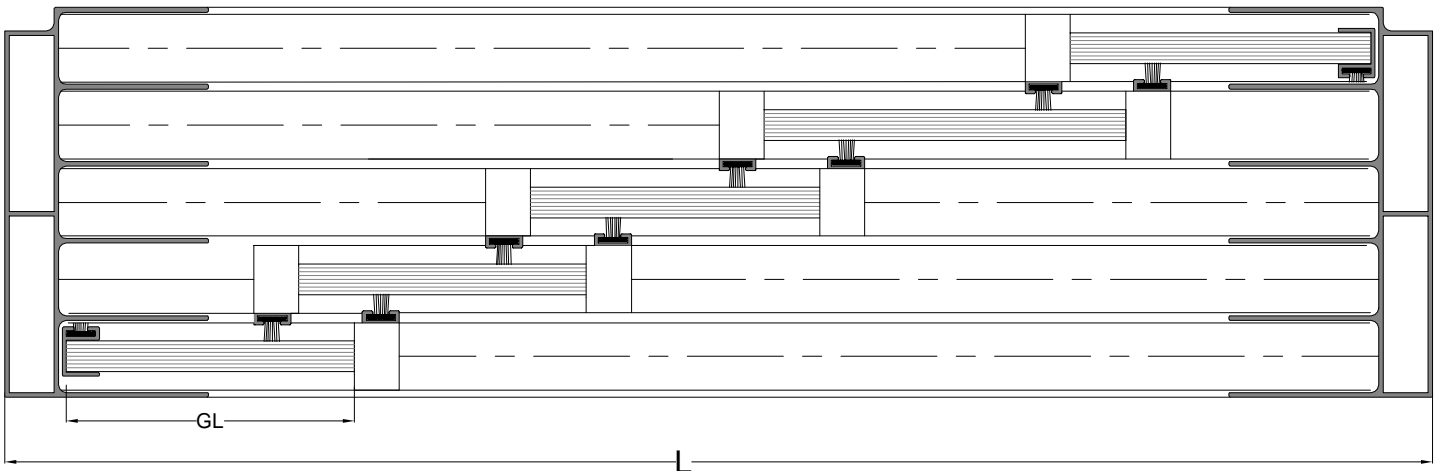

Eşiksiz Sistem Kesim Ölçüsü

PROFILE CUTTING DIMENSION FOR NON-THRESHOLD SYSTEM

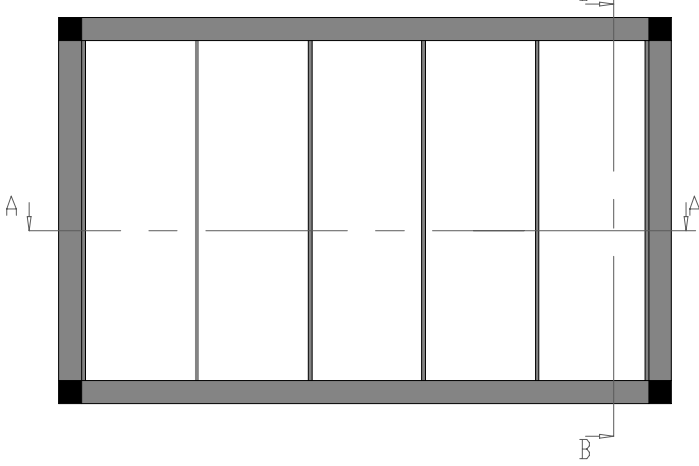

PROFİLLER / PROFILES

Kod Code	Çizim Drawing	Kesim Cut	Miktar Quantity	Ölçüler Dimensions
9678 Ray Profili Rail Profile			1Pcs / Adet	L
5430 Üst Kasa Top Frame			1Pcs / Adet	L-104
5430 Yan Kasa Side Frame			2Pcs / Adet	H-22
12017 Alt Kanat Bottom Sash			A x 1	$\frac{L}{A} + 8$
5929 Üst Kanat Top Sash			A x 1	$\frac{L}{A} + 8$
7187 Son Kanat End Sash			2Pcs / Adet	H-148
6198 Ara Kanat Middle Sash			8Pcs / Adet	

CAM / GLAZING

Kod Code	Çizim Drawing	Miktar Quantity	Ölçüler Dimensions
CAM GLAZING		5 Pcs / Adet	GH=H-132 $GL = \frac{L}{A} + 8$

CAM ÖLÇÜLER EĞİT KABUL EDİLEREK FORMÜLE EDİLMİŞTİR.
GLAZING DIMENSIONS ARE ASSUMED TO BE EQUAL.

B-B KESİTİ

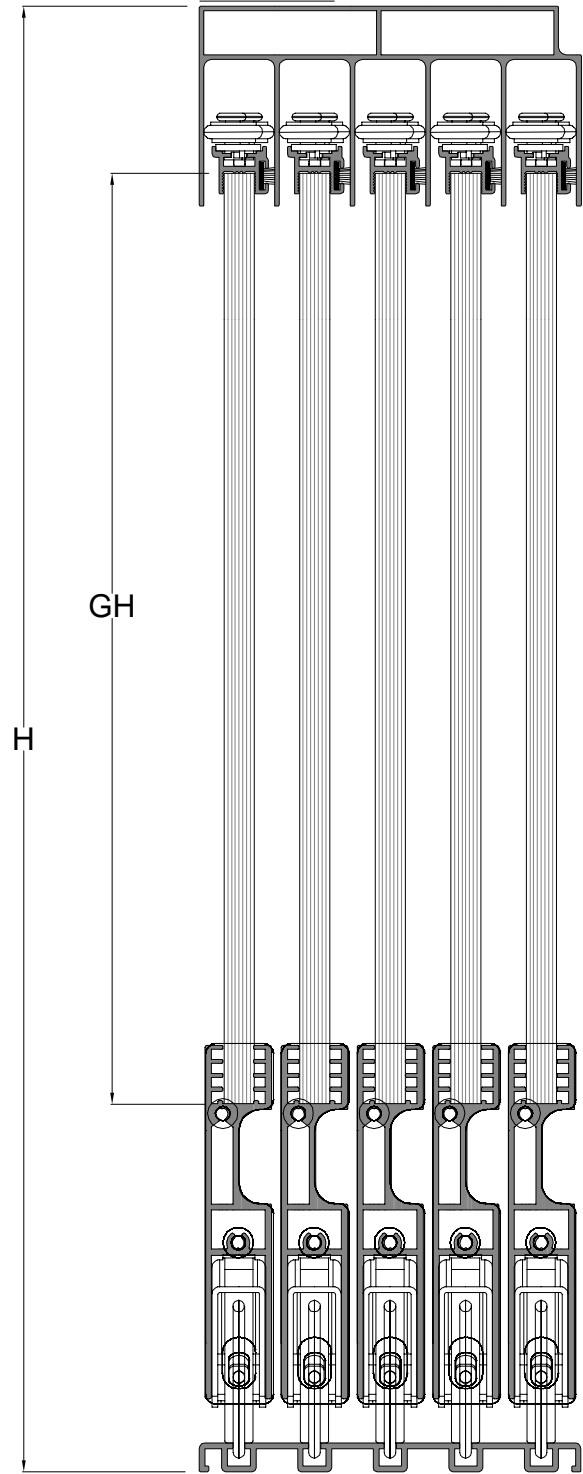

A-A KESİTİ

